

BriteMED[®] 21" Medical Monitor

Touch Function for Medical Modality Control Terminal



* Stand is optional

Benefits



Versatile Connection

Multiple analog and digital inputs/outputs, including HDMI loop-through, allow flexible connections and image sharing simultaneously.



Intuitive Touch Operation

The PCAP multi-touch screen enables easy operation even in latex gloves, facilitating procedure of image-viewing and information accessing.



Easy to Clean

The special-coating glass not only ensures precise image viewing experience under strong OR lighting but also brings easy-to-clean advantage required for infection control.



Accurate Image Viewing

The DICOM and GAMMA compliance ensures precise color and grey scale reproduction, satisfying medical imaging requirement and assisting further diagnosis.

Selection Guide

	With VGA & DVI input for general connection	With analog video input for traditional system	With 3G-SDI input for advanced system
Without HDMI Input/output	MMS-21CT	MMS-21CAT	MMS-21CST MMS-21CAST
With HDMI Input/output for PIP/PBP Display	MMS-21CHT	MMS-21CAHT	MMS-21CHST MMS-21CAHST

Dimensions (unit: mm)

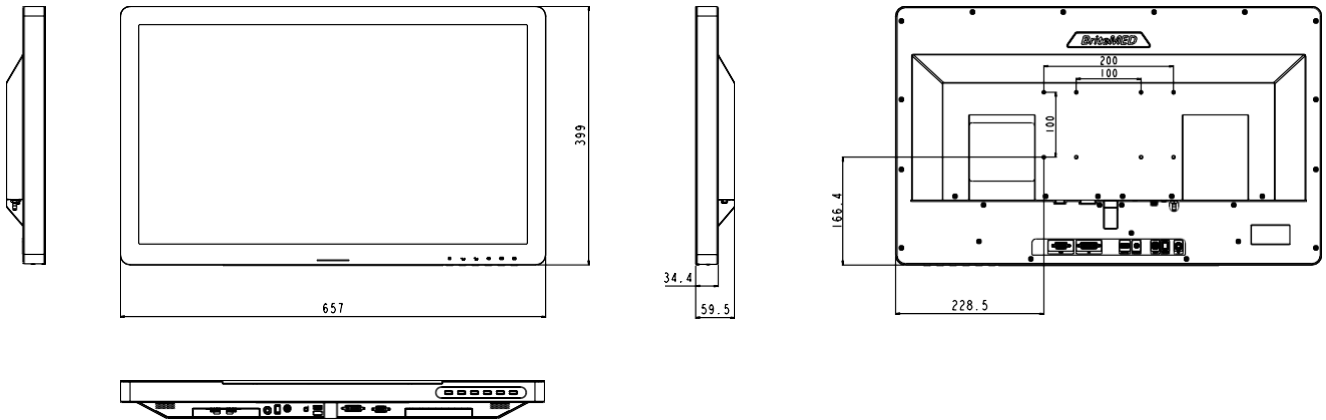

Signal Interface

MMS-21CT

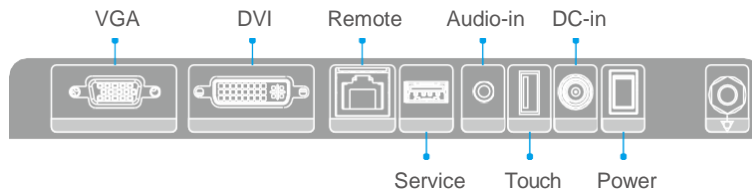

MMS-21CAT

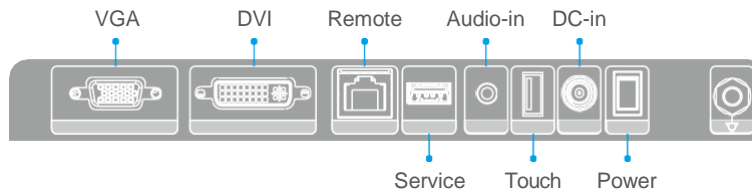
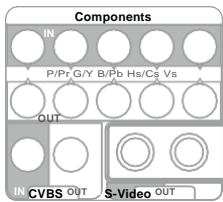

MMS-21CHT

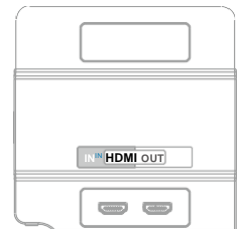
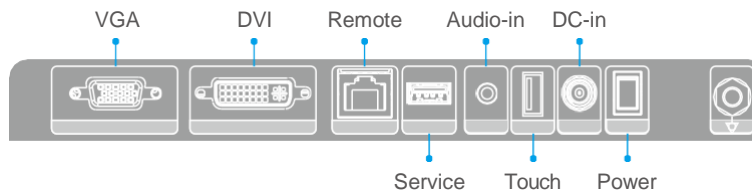

MMS-21CAHT

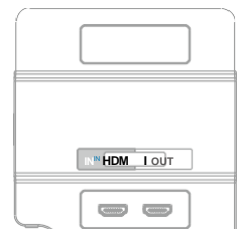
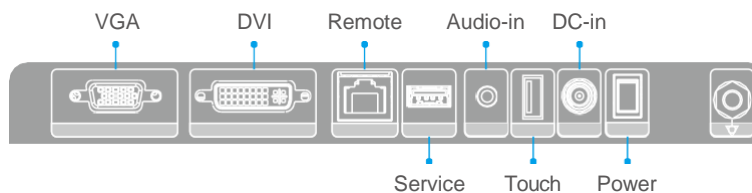
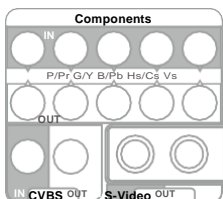

MMS-21CST

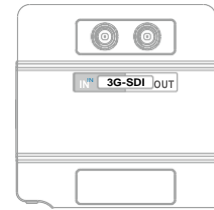
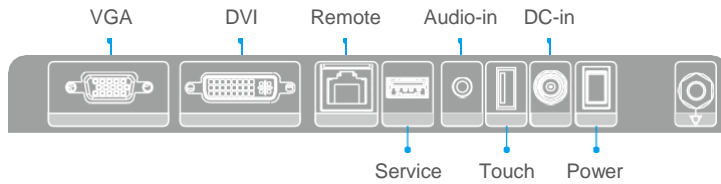

MMS-21CAST

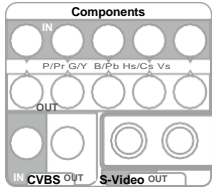
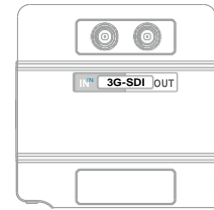
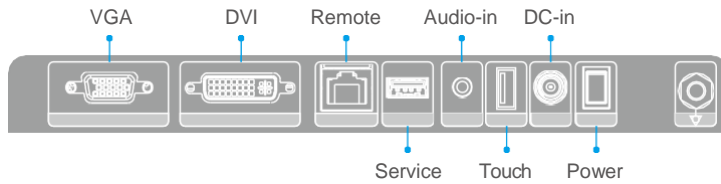

MMS-21CHST

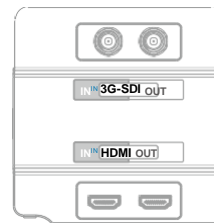
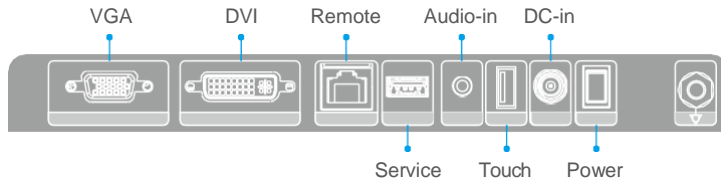

MMS-21CAHST

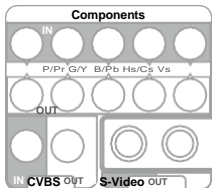
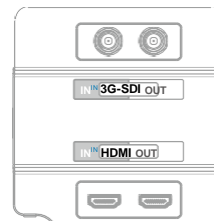
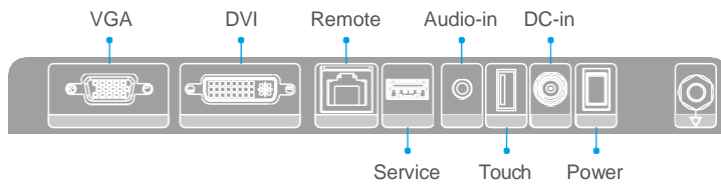

Ordering Information

Part No.	Description
MMS-21CT-R11	21.5", White, 1920x1080, VGA/DVI-D input, P-CAP Touchscreen, 100~240 VAC to 12V DC power adaptor
MMS-21CAT-R11	21.5", White, 1920x1080, VGA/DVI-D/Component/CVBS/S-Video input, P-CAP Touchscreen, 100~240 VAC to 12V DC power adaptor
MMS-21CHT-R11	21.5", White, 1920x1080, VGA/DVI-D/HDMI input, P-CAP Touchscreen, 100~240 VAC to 12V DC power adaptor
MMS-21CAHT-R11	21.5", White, 1920x1080, VGA/DVI-D/Component/CVBS/S-Video/HDMI input, P-CAP Touchscreen, 100~240 VAC to 12V DC power adaptor
MMS-21CST-R11	21.5", White, 1920x1080, VGA/DVI-D/3G SDI input P-CAP Touchscreen, 100~240 VAC to 12V DC power adaptor
MMS-21CAST-R11	21.5", White, 1920x1080, VGA/DVI-D/Component/CVBS/S-Video/3G SDI input P-CAP Touchscreen, 100~240 VAC to 12V DC power adaptor
MMS-21CHST-R11	21.5", White, 1920x1080, VGA/DVI-D/HDMI/3G SDI input P-CAP Touchscreen, 100~240 VAC to 12V DC power adaptor
MMS-21CAHST-R11	21.5", White, 1920x1080, VGA/DVI-D/Component/CVBS/S-Video/HDMI/3G SDI input P-CAP Touchscreen, 100~240 VAC to 12V DC power adaptor

Factory Options

Part No.	Description
STAND-DWH-R10	VESA 75/100 stand, supports up to 15 kg, white
AFLWK-19B	VESA 100 wall mount kit, supports up to 7.5 kg, silver



MMS-21CT-Series_
datasheet_V1_20210201

Britemed Technology Inc.

3F., No.306/306-3, Sec. 1, Datong Rd., Xizhi Dist., New Taipei City 22146, Taiwan
 TEL: +886-2-86919498
 FAX: +886-2-86919468
www.britemed.com.tw

Specifications may change without further notice.
 © 2021 BriteMED Technology Inc. All rights reserved.

Celebrate Humanity With Technology